

14500 Coy Drive, Grass Lake, Michigan 49240
734-475-2200 E-mail: sales@coylab.com
www.coylab.com

Hypoxic Chamber Manual

For Polymer O2 Control Glove Boxes Only

Index

	<u>Page</u>
Warranty	2
Warnings	3
1.0 Setup Procedure (Glove Box)	5
2.0 Setup Procedure (Gas Supply)	15
3.0 System Function	15
4.0 Control Cabinet	17-24
5.0 Establishing Initial Atmosphere	31-33
6.0 Care of Polycarbonate	33-34

WARRANTY

This product is warranted against defects in material and workmanship during the first 12 months after original date of shipment.

The factory will, at its option, repair or replace defective material within this period at no charge for parts and labor.

All returns or exchanges must first be authorized by COY LABORATORY PRODUCTS, INC.

PHONE: 734-475-2200

FAX: 734-475-1846

COY LABORATORY PRODUCTS, INC.

14500 COY DRIVE

GRASS LAKE, MI 49240

The responsibility of COY LABORATORY PRODUCTS, INC. is limited to the purchase price of this product, and COY LABORATORY PRODUCTS, INC. will not be responsible for any consequential damages.

This warranty does not cover damage in shipment or damage as a result of improper use or maintenance of this product. This warranty does not cover damages caused by excessive line transients on the AC supply line.

WARNINGS

1. The calibration of the sensor must be checked frequently as erroneous low readings can result from a degraded sensor.
2. Gas pressures into the back of the Oxygen Controller must not exceed 10 PSI.
3. The output of the O₂ Controller must be regulated using the controls on the front of the Controller, not to exceed a total of 40 SCFH. If the gas flow exceeds 40 SCFH, there is a danger the Sensor will not detect the rapid change, thus causing the gas level to exceed your set point value.
4. Never obstruct gas flow in or out of the Relief Valves.
5. Never attempt to service the O₂ Controller. Call COY LABORATORY PRODUCTS, INC. for assistance.
6. Never put an open flame or create a spark in a Chamber, especially under hyperoxic conditions.
7. The sensor cell membrane is delicate. Do not scratch, puncture, or permit sharp objects to touch the cell face. Sensor failure due to mishandling voids the sensor warranty.
8. **Never pull a vacuum** on Polymer or Aluminum Glove Box. This could crack/damage the glove box and void the warranty.
9. **LATEX WARNING** Latex Gloves/cuffs with powder may be installed on this equipment. Some people are allergic to latex and/or the powder. COY Laboratory Products cannot account for the content of gloves bought from other vendors.

Figure #1A: Standard Glove Box Front View (1 Person Size)

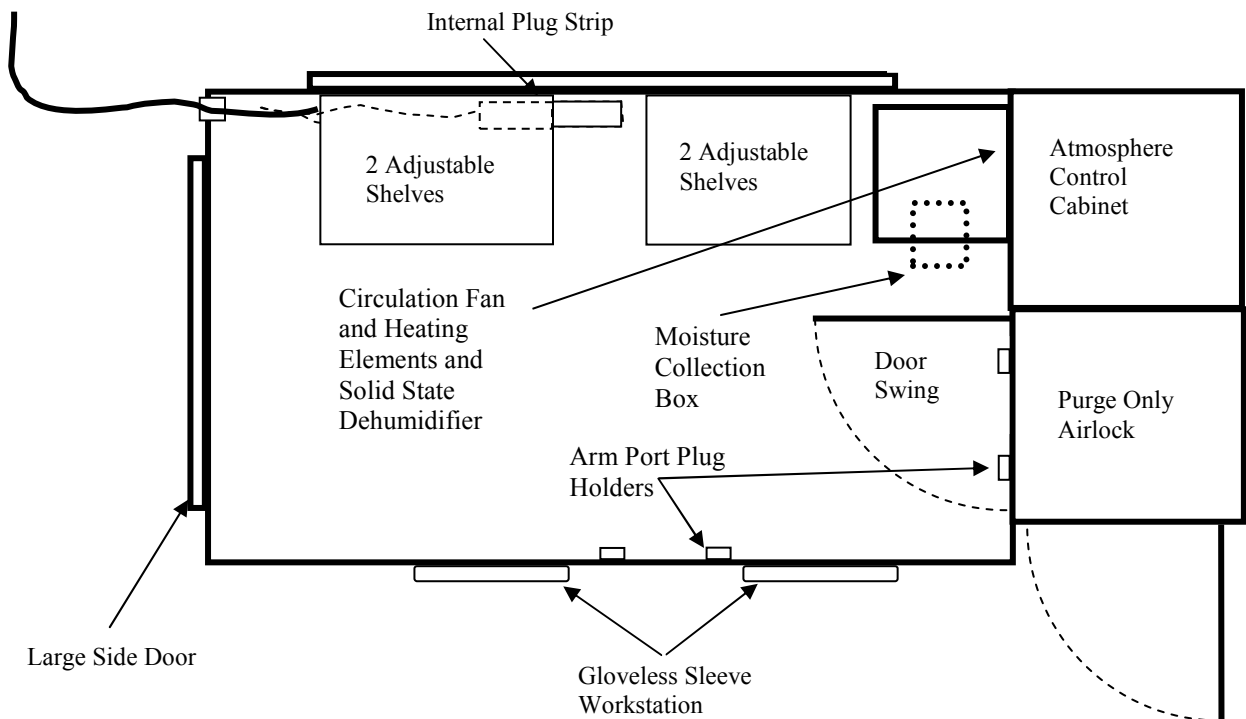
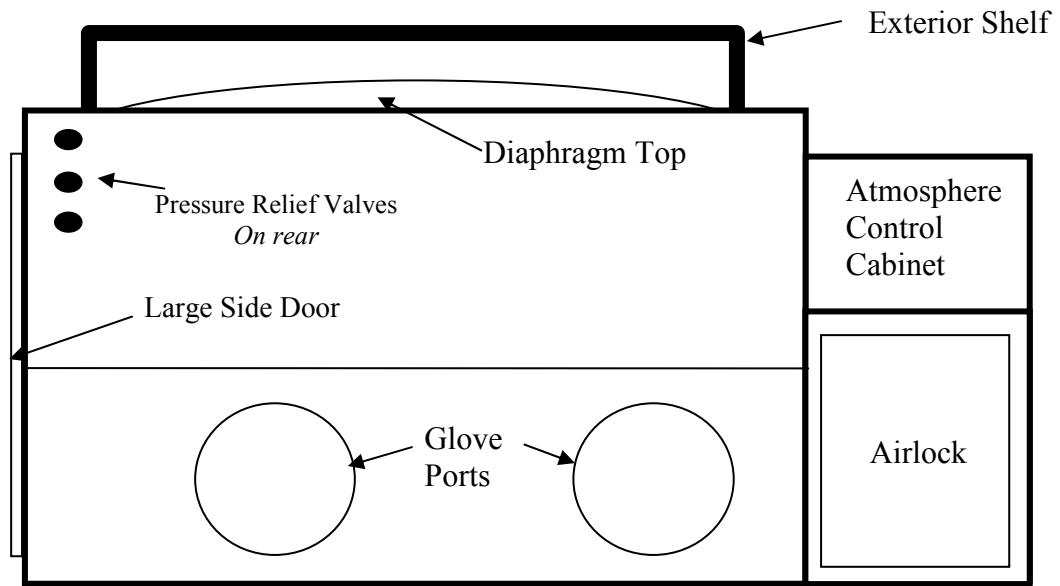

Please note: actual Glove Box configuration could vary based on options chosen, drawing is only provided as a general reference.

1.0 SETUP PROCEDURE (Glove Box)

ASSUME THE AIRLOCK IS ATTACHED TO THE RIGHT SIDE OF THE GLOVE BOX.

1) Unpack all materials for the Glove Box. *DO NOT THROW AWAY PACKING/CRATING MATERIAL* until all goods have been checked and received.

Set up your compressed gas lines or tanks near where you want to install the Glove Box. Have the gas regulated to a maximum of 10 psi. The tubing lines leading to the Controller, Glove Box and Airlock from your supplied Background gas tanks are supplied with the instrument (flexible Tubing with quick disconnects). For connection of an Oxygen Tank, a separate O2 Regulator (*Part # 7004-020*) should be ordered from COY Laboratory Products.

2) Position Glove Box in the desired workspace in the lab, and place the Arm Port Plugs into the arm port holders attached to the interior front of the glove box. (See figure #1A + 1B) The Gloveless Sleeves are installed at the factory (see section 6.0 for details on replacing the sleeves and the cuff).

Figure #1B: Installation of Arm Port Plugs

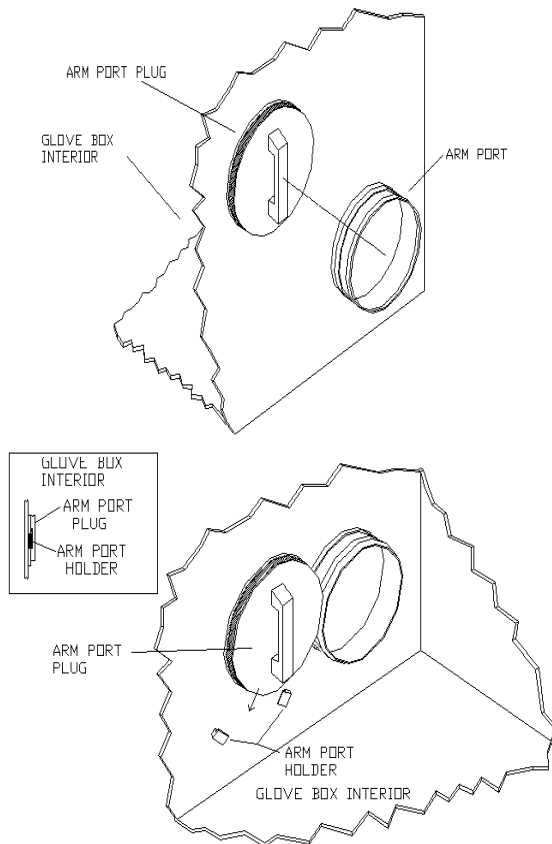
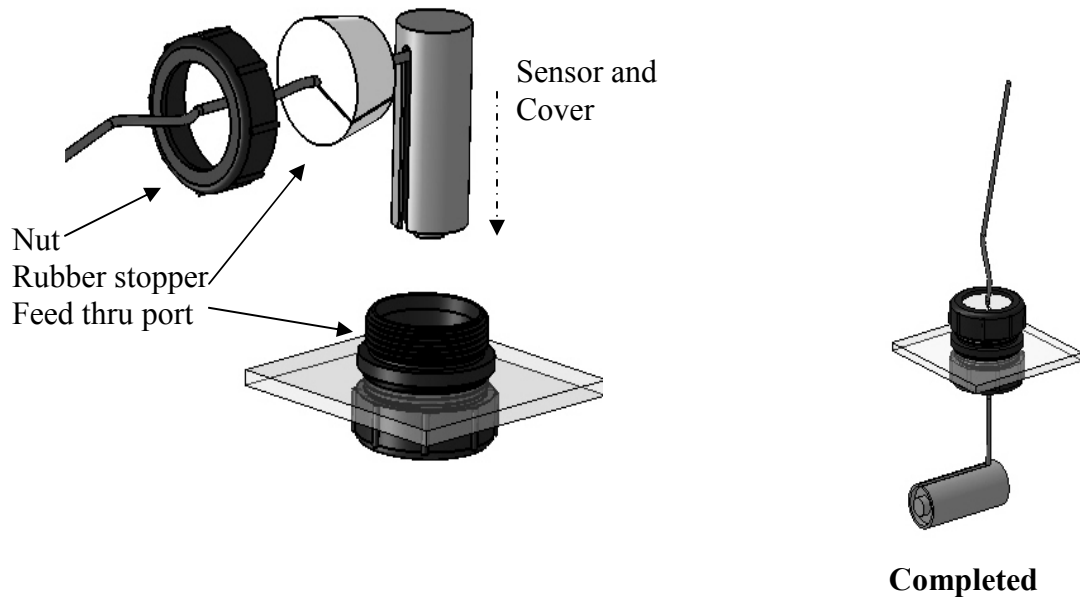

Figure #2 Mounting O2 sensor through Feed Thru-Port



3. Mounting O2 sensor into chamber:

Step 1) Position the Chamber as desired, and then place the Oxygen Controller on the Exterior Shelf Provided (Shelf located on Top of Polymer unit or Side of an Aluminum unit).

Step 2) Plug the Oxygen Sensor into the jack on the back of the Controller.

Step 3) Take the Sensor Cover and slide down the slotted end over the Blue O2 Sensor wire.

Step 3) Feed entire sensor **and** cover down through the mounting Feed thru port as seen above. (It is ok to bend the sensor cord as you push into chamber)

Step 4) Using the predrilled, precut rubber stopper insert the O2 sensor cord. Push the rubber stopper down into the port as far as possible and screw the nut down tightly.

Make sure the sensor hangs about 3-4 inches below the chamber. Finally slide the O2 sensor cover. (See Figure #2)

4. Removing O2 sensor:

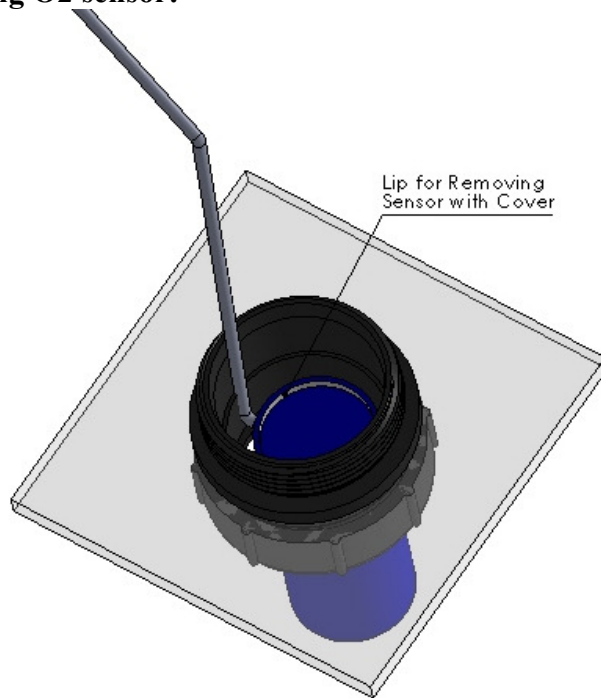

1. Remove rubber stopper
2. Insert index finger into sensor port. By using the lip on the cover you will be able to pull on the sensor cover to allow it to travel back up and out of the sensor port.

Installing the CO2 sensor option: *(skip if you did not buy Co2 Controller option)*

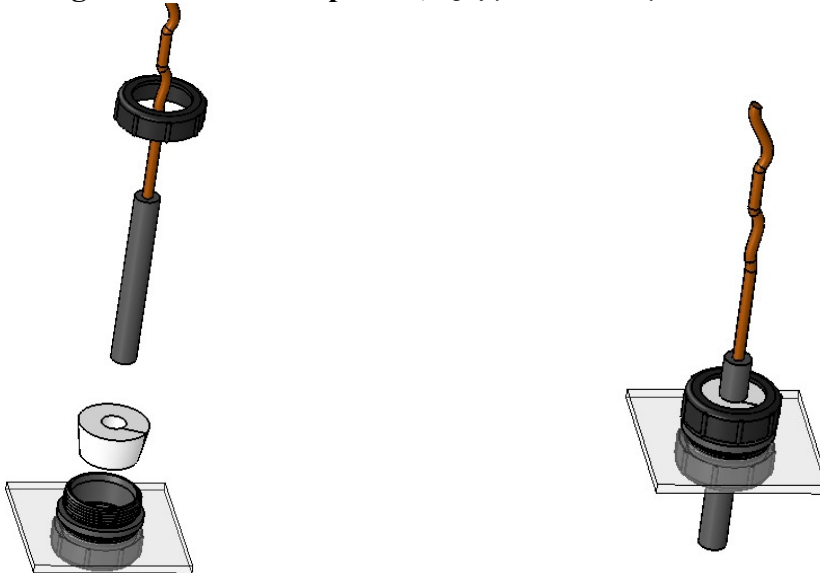

Step 1) Slide the Co2 sensor down through the Nut

Step 2) Using the predrilled large hole rubber stopper, insert the Co2 sensor up until 1 inch of the sensor is sticking out of the top.

Step 3) Push the rubber stopper back into the port as far as possible and screw the nut down tightly. The Co2 sensor should be about 2-3 inches into the chamber.

Figure # A Tubing connection to Quick Disconnect Fitting & “T” Fitting

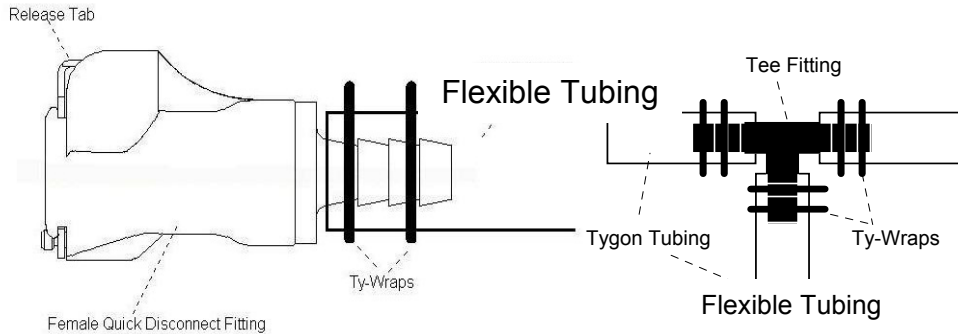

Using the tubing provided, install the gas lines from the source tanks to the Glove Box, O2 Controller, and Airlock, see pages 9-12 for connections. A Gas Manifold for the Background Gas (nitrogen) is provided on the center/top in an unheated system and behind the Atmosphere Control Cabinet of the heated systems. The Gas Manifold has detailed labels for each fitting to assist in this task. Tubing will have to be cut to fit and the proper fittings as instructed below.

NOTE: Units with the Atmosphere Control Cabinet do not require the “To Ball Valve On Glove Box Connection” so this fitting has been capped.

5) To install flexible tubing to the fittings follow the instructions listed below and Figure #A, below as a reference

- A. Place a female fitting on each end of tubing.
- B. Place 2 ty-wraps around the hose barb on the female fittings and pull them as tight as possible.
- C. Cut off excise ty-wrap.
- D. Insert Female fitting connected to the tubing to the Male fitting on the Glove Box Ball Valve. When fitting is seated correctly, you will hear a “click”.
- E. To disconnect the tubing simply depress the silver tab on the male fitting and separate.

When disconnected the fittings on the glove box automatically seal the glove box atmosphere.

NOTE: Never purge the glove box at a higher rate than 10 psi. (With ¼” OD Tubing) Doing so could over pressurize and damage the glove box. Damage from over pressurizing the glove box will void the warranty.

Figure # 4 - Hypoxic Chamber/Glove Box, Plumbing Diagram

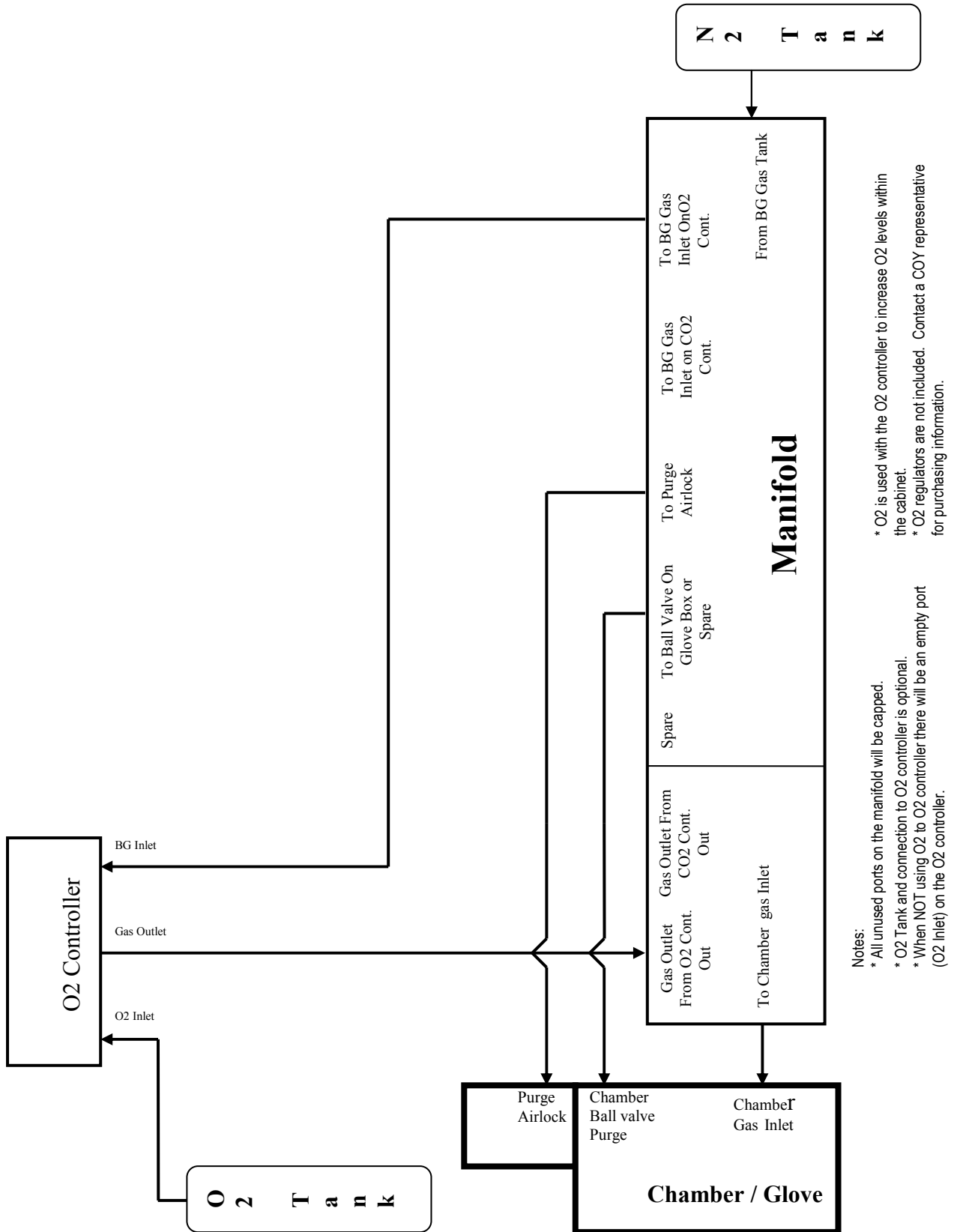
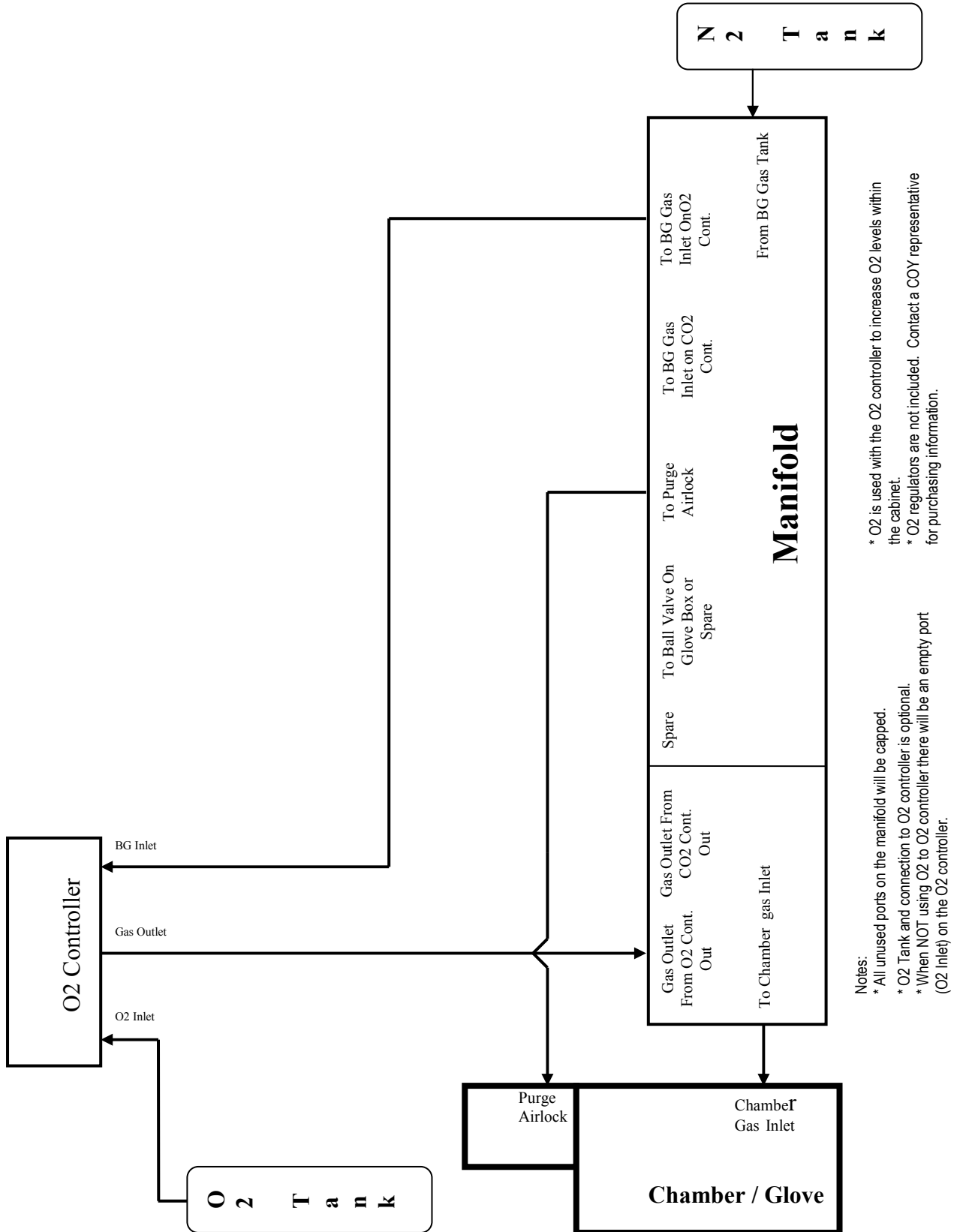

Figure # 5 - Hypoxic Chamber/Glove Box with Heater, Plumbing Diagram



Notes:
 * All unused ports on the manifold will be capped.
 * O2 Tank and connection to O2 controller is optional.
 * When NOT using O2 to O2 controller there will be an empty port (O2 Inlet) on the O2 controller.
 * O2 is used with the O2 controller to increase O2 levels within the cabinet.
 * O2 regulators are not included. Contact a COY representative for purchasing information.

Figure # 6 - Hypoxic Glove Box with CO₂ Controller, Plumbing Diagram

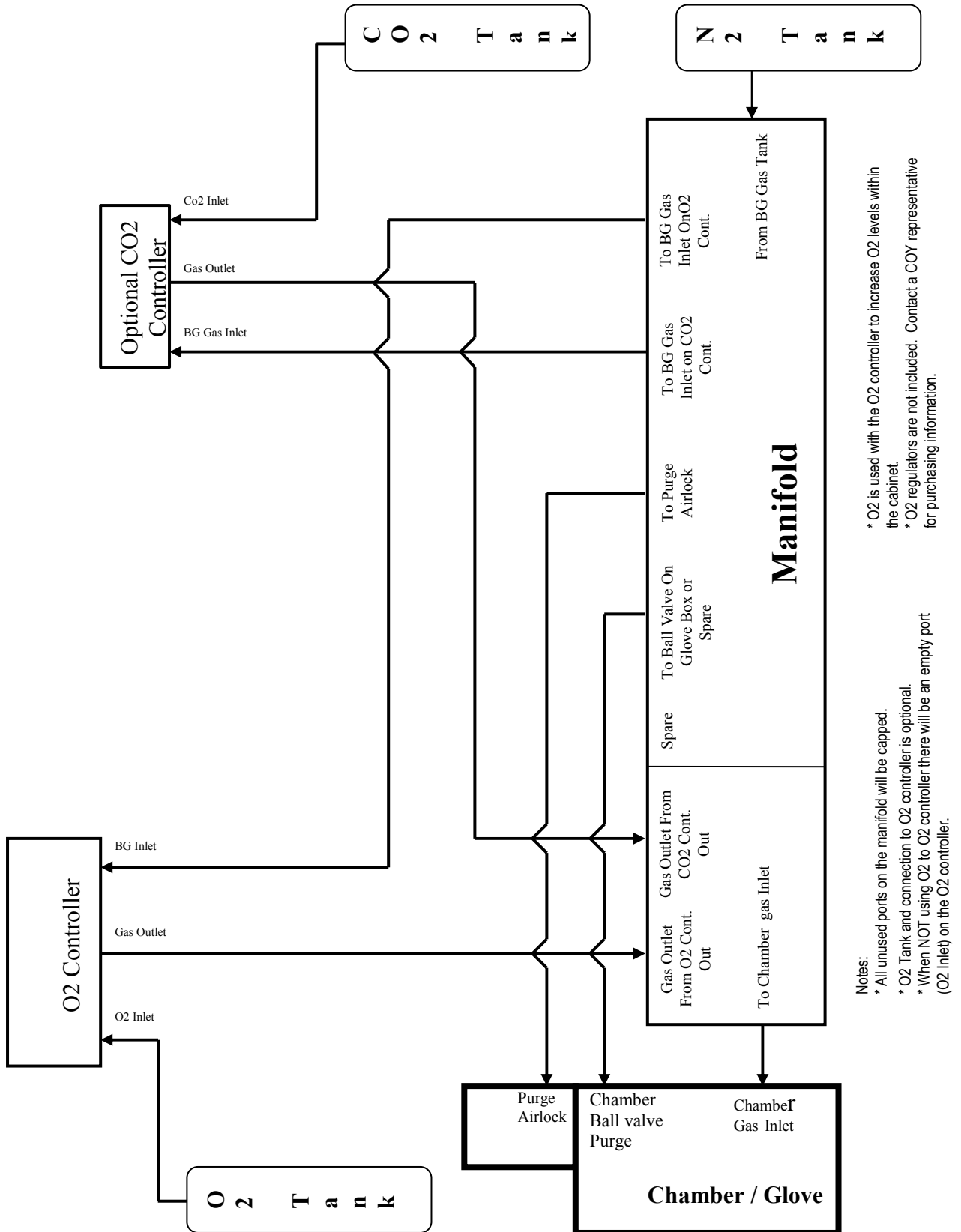
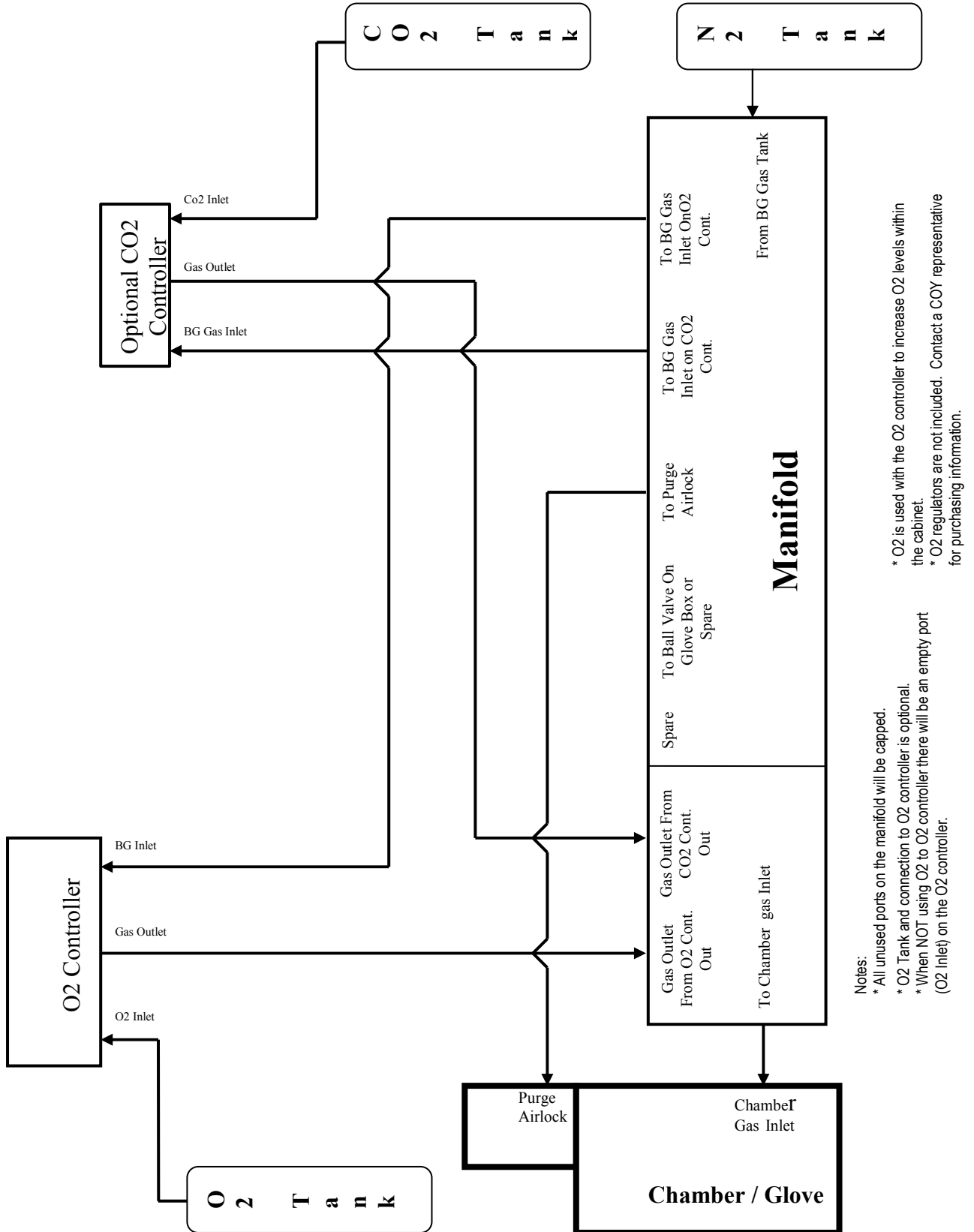

Figure # 7 - Hypoxic Glove Box with Heater and CO₂ Controller, Plumbing Diagram



7) Install the Shelving units: Install Support Brackets into the factory installed Support Rails on the rear of the glove box. Sometimes it is necessary to use a rubber mallet to install the brackets securely with a light tap. NOTE: If the Humidified Incubation Box has been purchased in the one Person Units the shelves farthest from the airlock will not be useable and should not be installed.

Two and One Person Units only

8.) Install the 2nd circulation fan, the unit is shipped with the brackets already installed but you will have to install the fan unit yourself. To install the fan, remove the black knobs (bolts) from the side of the fan/heater unit and install the fan to the fan base mounted into the chamber. (see Figure #B). When installing the fan unit the Power Cord should always face the rear of the glove box. Adjust angle of the fan so that the airflow is pointed toward the top third of the glove box and tighten the bolts holding it in place. Plug power cord into the Supplied Plug Strip. On the back of the circulation fan for the One Person units is an OFF/HI/LOW switch, for best temperature and humidity uniformity in the glove box this should remain in the HI position.

For the Heated Fans on the 2 Person Units the fan starts automatically when the plug strip is turned on. For operation of the temperature controls please see page 28.

Figure #B: Circulation & Heater Fan Assembly

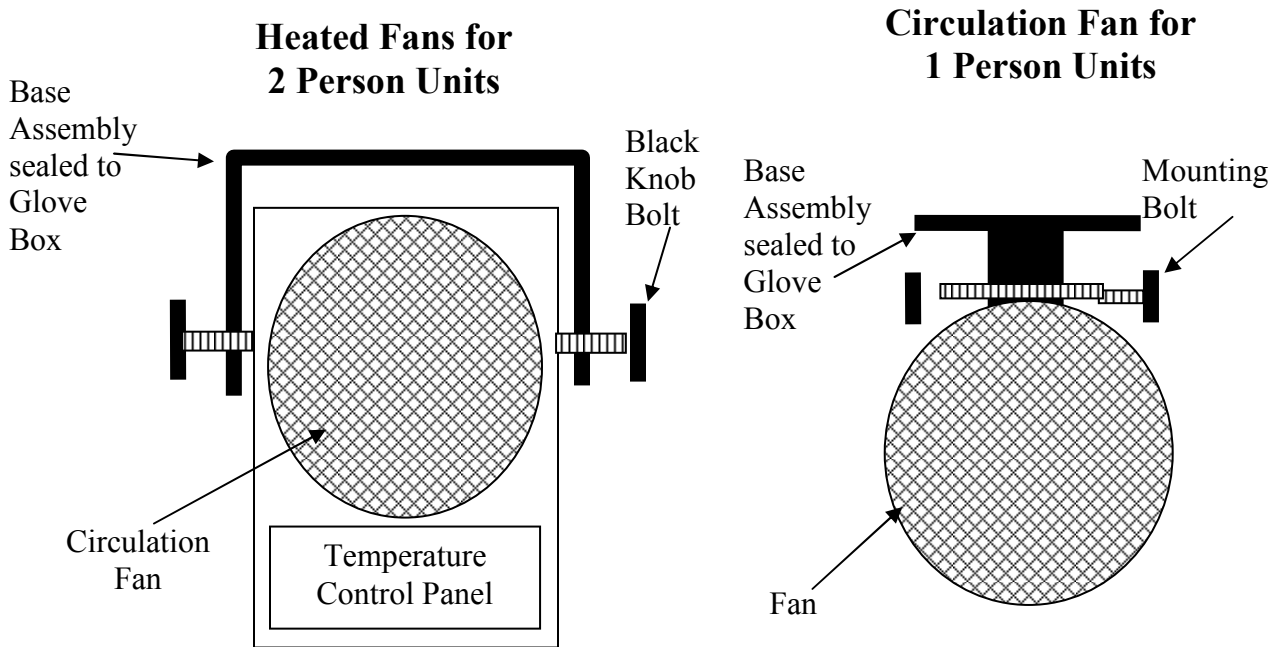

For options with Automatic Dehumidifier option

- 9) An empty square plastic container is supplied with the chamber to capture the condensed moisture from Dehumidifier. Next to the Atmosphere Control Cabinet's circulation fan is a tube for the condensed moisture, insert the tube into the bottle. This will have to be emptied every so often based on chamber operation.

Set Up for Humidified Incubation Box Option

10) (Use Figure #C below for reference.) Attach the small diaphragm pump to the blue filter using the flexible flexible tubing. Attach the filter using another piece of flexible tubing and fitting on the Incubation Box. For optimum performance, the Incubator Box should be level.

Fill the water reservoir with distilled water and place inside the Incubation Box. Do not over fill the water in the reservoir.

NOTE: For 220 volt units the pump is not supplied. A locally purchased one we have to be provided.

Figure #C Humidified Incubation Box (large size pictured)

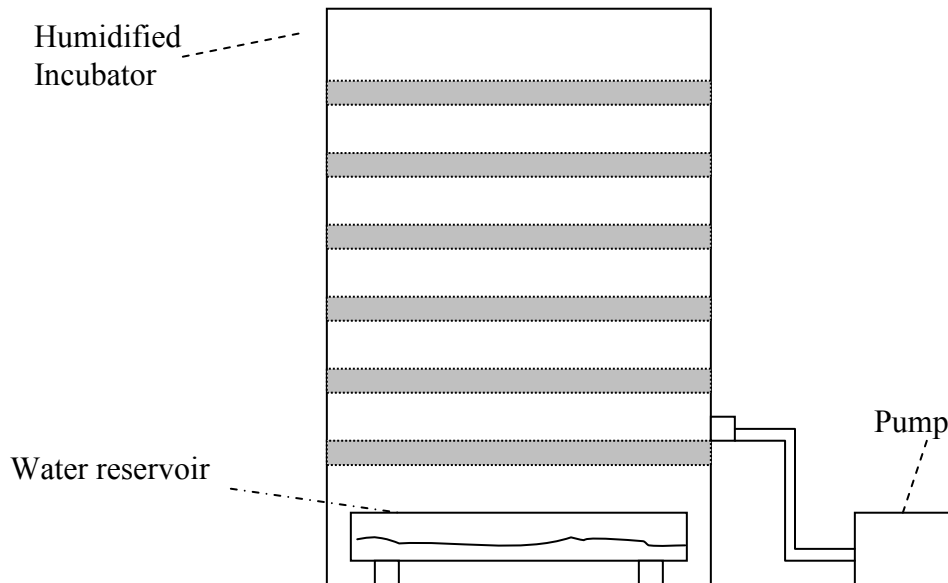

- 11) Once all your equipment is in place and situated to your satisfaction, close the large side door and place the arm port plugs in the arm ports (see figure #1A, 1B) sealing the glove box atmosphere and proceed to section 2.0.

2.0 GAS SUPPLY SETUP PROCEDURE

Passive CO₂ Control

If optional CO₂ Control System has been purchased skip this part and move on to Section 3.0 System Function.

To maintain the 5% CO₂ level required for certain buffers to function properly, use the following table to spike each one of the gases going into the Oxygen Controller with the appropriate level of CO₂ based on desired O₂ levels.

Desired Concentration of Oxygen	Air Displace to %	%CO ₂ Mix required	Desired % Co ₂	%CO ₂ Concentration in N ₂
20.80	100.00	0.00	5.00	N/A
15.00	72.12	27.88	5.00	17.9310
10.00	48.08	51.92	5.00	9.6296
5.00	24.04	75.96	5.00	6.5823
2.00	9.62	90.38	5.00	5.5319
1.00	4.81	95.19	5.00	5.2525
0.50	2.40	97.60	5.00	5.1232
0.10	0.48	99.52	5.00	5.0242

3.0 SYSTEM FUNCTION IN CHAMBER

3.1 Standard Equipment

*Note: Some of the following items (noted with a *) come with a complete manual which should be consulted for more detailed information prior to operation.*

1. O₂ Controller*
2. Touch Screen Controls (heated units only)
 - Temperature
 - Dehumidifier
 - Purge Airlock
 - Glove Box Purge
 - Temperature and Dehumidifier Calibration
3. Plug Strip
4. Diaphragm Top
5. Nitrogen (background) Gas Regulator
6. Heated Circulation Fan (2 Person Units only)*
7. Gloveless Sleeves & Arm Port Plugs

1. O2 Controller

The Oxygen Controller is intended to maintain an oxygen level in the glove box by sensing the current concentration and then opening the appropriate solenoid valve to allow gas to flow and purge the glove box. The Oxygen set point (SP1) and background gas set point (SP2) are used to set the oxygen range desired in the Chamber. We suggest the range be adjusted to your desired level +/- 0.1%. It can be programmed to maintain a wider range, which may be of use when working with elevated oxygen levels. A call to the factory will help you to reprogram your Controller.

SP1 and SP2 should always be set at the desired oxygen level

When the solenoid is opened to allow gas flow, you will hear a metallic click and the flow meter of the appropriate gas will rise to the set level.

Under normal use, only one gas line will be open at a time. The flow must be adjusted using the flow meters on the front of the Controller. If the Controller has been incorrectly set, or there is a malfunction, it is possible to have both gases flowing at the same time. For this reason, there is a warning sign on the front of the Controller to adjust both flow meters to a combined flow rate of 40 SCFH. Gas inlet pressures must be regulated at the source to 10-15 psi. UNDER NO CIRCUMSTANCE SHOULD THE INLET PRESSURE EXCEED 15 PSI. See below for specifics on desired flow rates.

To obtain uniform O₂ concentration throughout the glove box, the Fan(es) must be on at ALL times when the Controller is operating.

The alarm (AL) and temperature (C°/F°) functions are not included with the Oxygen Controller, therefore these indicator lights will not work.

To check gross calibration of the oxygen sensor, remove it from the Glove Box Wall and measure ambient conditions. Allow 30 minutes for temperature and oxygen stabilization. The ambient condition should be 20.9%.

NOTE: Standard temperature operating range for the O₂ Controller is 0-43 ° C. Below are recommended Flow Rates

Type/Size	Flow Rate (SCFH)	Flow Rate (SCFH)
<i>Polymer and Aluminum, Chamber / Glove Box</i>	O ₂ Gas*	Background Gas
Mini Polymer	≤ 2	≤ 10
1 Person Polymer/Aluminum	≤ 2	≤ 10
2 Person Polymer	≤ 4	≤ 20
2 Person Aluminum	≤ 6	≤ 30

*NOTE: The O₂ Flow Rates assume a 100% tank of O₂ is used. For forced air or other % of O₂ rates will have to be increased.

The gas flow on the Flow Meters can only be adjusted when gas is flowing through.

4. Atmosphere Control Cabinet Touch Screen Controls – Heated Units only

Figure #7: Atmosphere Control Cabinet Control Panel

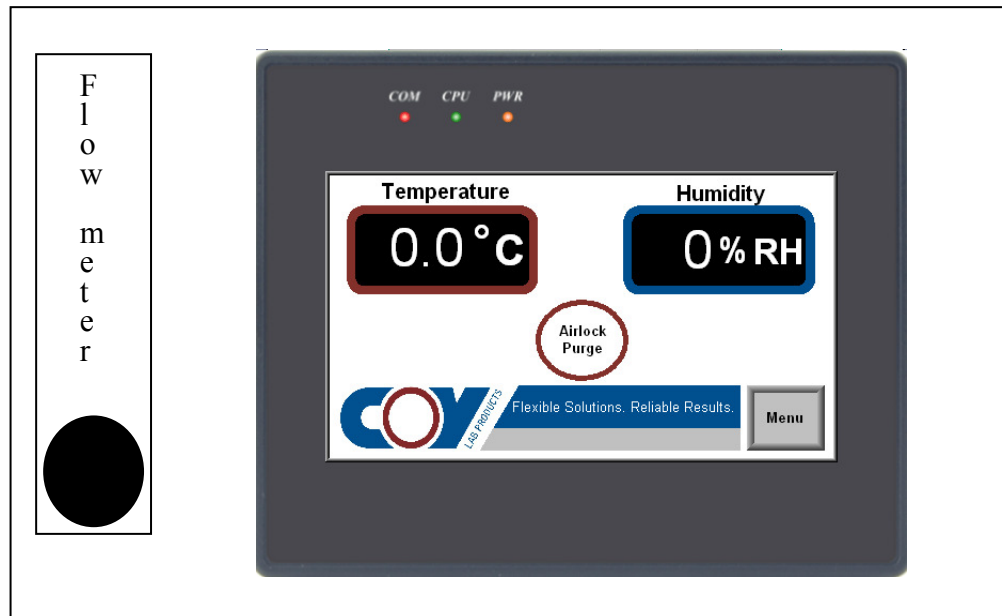

General Touch Screen Menu Guide

The touch screen controls allow you to control airlock purge times, direct glove box purge, Temperature set points and On/Off controls for the dehumidifier.

Touching the logo will send you to a Help menu for Frequently Asked Questions, System Menu which controls the screen saver and calibration menu and related COY Products Menu you may find useful in the future.



The icon will return you to the home screen (see above).



The icon will send you back to the previous page.

A Screen Saver is present that will send the monitor to a black screen (looks like the unit is off except for the top LED's lit. Touching any part of the screen will remove the screen saver.

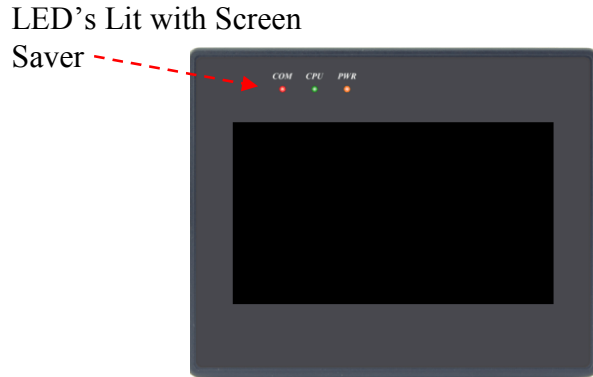

The Screen Saver timer is adjustable and accessible through the **Menu > Help > System buttons**. Timer adjustment is in minutes with 255 minutes the maximum allowable.

Also in the help menu is a frequently asked questions (FAQ) guide.

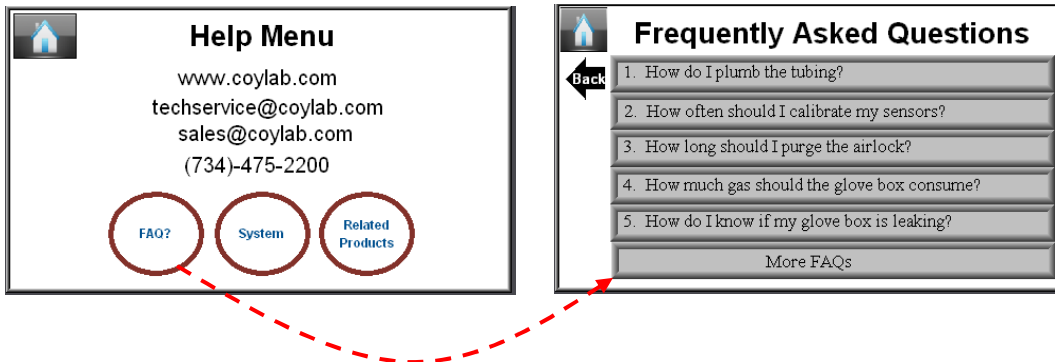

2.2 Temperature Control: how to input the desired set point.

Temperature can be controlled from +4 ambient to 40° C using the touch screen menu. To adjust the temperature follow use the following instructions.

This control is based on the thermal couple that's location can be adjusted inside the glove box. The Ideal Placement will be on 1 of the shelf units placed so that the air flow is not blocked and the thermal couple is not in contact with anything.

1. Press Menu Button

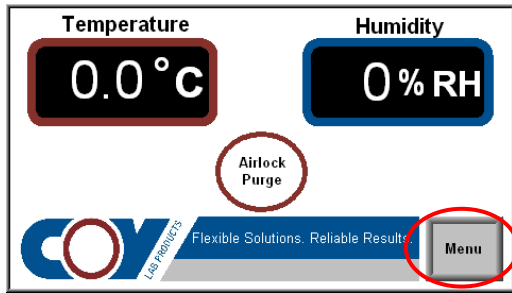

2. Press Temperature Setpoint menu button

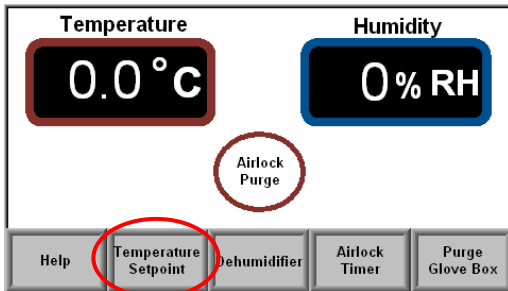

3. Enter the desired set point 1 of 2 ways. By clicking the green arrow buttons (up/down) on either side of the set point until desired temperature is reached or press the center of the red set point to bring up the quick screen button (hint: looks like a calculator).

Green Arrow Buttons

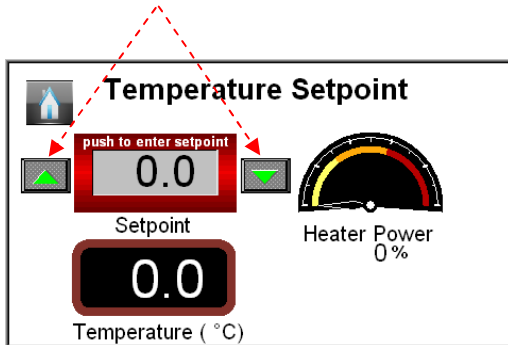

Selected the desired set point from this menu and press enter. The Heater Power display simply indicates that the internal heaters of the glove box are on and working. The chosen set point will be displayed in the bottom display.

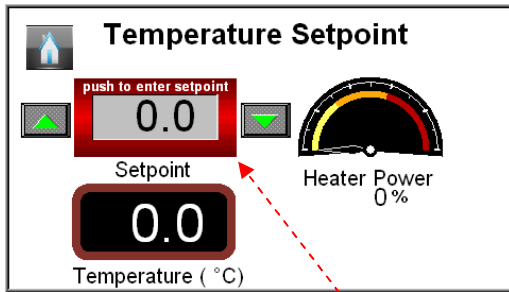

Clicking the center of the Set Point brings up the set point menu indicated here on the right

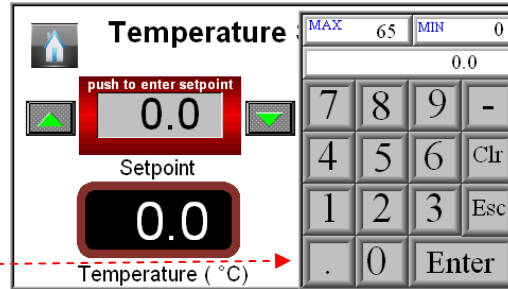

2.3 Dehumidifier On/Off

The built in dehumidifier is designed to maintain non-condensing levels of moisture in the chamber and for most studies should be in the On position. This should maintain between 30-35% Rh.

To Access the Dehumidifier menu and On/Off buttons press the Humidity Display (alternatively you can access this through the menu).

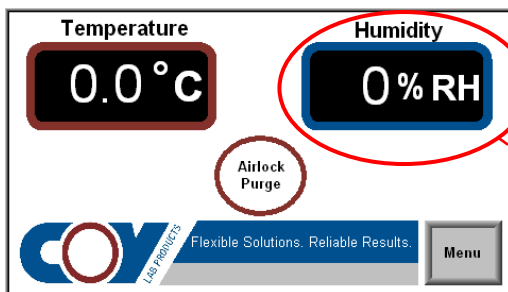

On/Off button

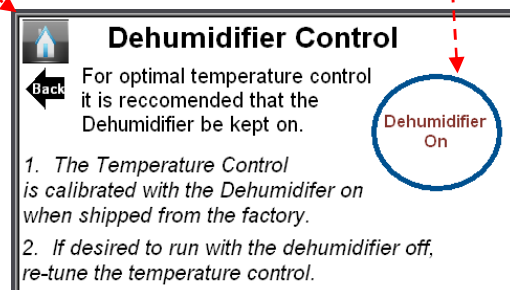

NOTE: When the Dehumidifier is turned off the primary display/monitoring page will indicate this with an icon under the %Rh display (see the example below)

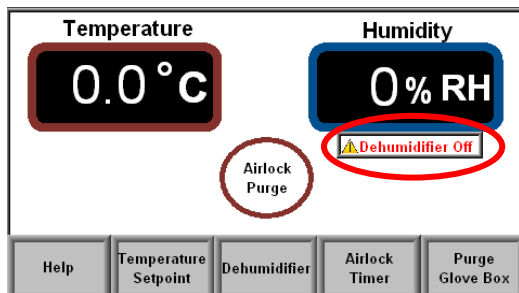

For optimal Temperature control it is recommended to operate the system with the Dehumidifier on. In addition to better temperature accuracy it will also minimize O₂ and CO₂ sensor failure due to moisture. If you do wish to operate the system with the dehumidifier in the off position it is recommended that you recalibrate the temperature controls.

2.4 Purge Airlock

For Heated Units the Controls are located on the Atmosphere Control Cabinet in the touch screen menu, for unheated units the Controls are part of a separate control box.

This unit purges the airlock for a set amount of time at an adjustable flow rate by the user, to reduce the amount of oxygen that is introduced to the Glove Box when bringing in materials and equipment when the interior door is opened.

Flow Meter

Rates are adjusted using a Flow meter located to the left of the touch screen control panel. Flow Meter should be preset prior to starting any use of the glove box. To preset the Flow meter you must have flow through the system. Using the black knob at the bottom of the flow meter will increase or decrease this flow rate. The measurement's are in SCFH (Standard Cubic Feet per Hour) from 0-180. The times in the sample chart for O₂ levels below assume 90 SCFH.

Touch Screen Controls-Automatic only Units

Start/Stop the purge process

The default monitoring screen displays the airlock start purge button in the center of the screen. Pressing this button will start the purge process for the amount of time selected. Once the button is pressed a timer appears counting down the purge time (you should also hear the air flow). A “STOP” Icon is displayed allowing the user to stop any purge in process. Once the stop button is pressed the timer will reset.

Note: if the timer is set for a very short period of time you may not notice the timer count down when pressing this button.

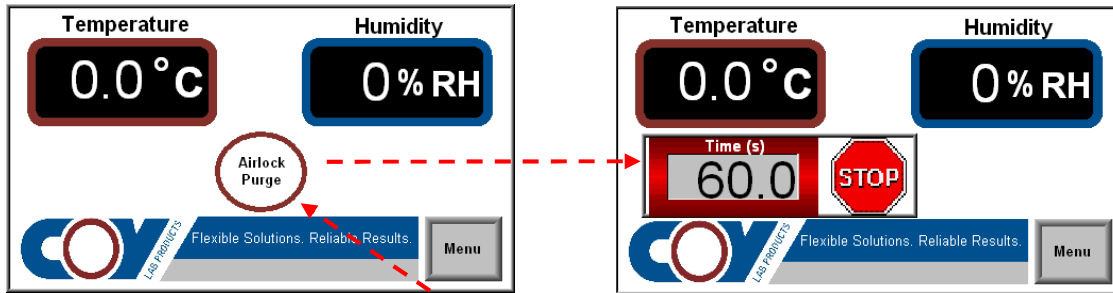

Pressing here brings up the Airlock Purge count down timer.

Adjusting Airlock Timer

NOTE: you can not operate the glove box purge and the airlock purge at the same time.

Purge times can be adjusted to account for various O₂ levels, and is the easiest way for most users to make adjustments for the various O₂ levels needed.

To adjust times use the following steps

1. Press Menu Button

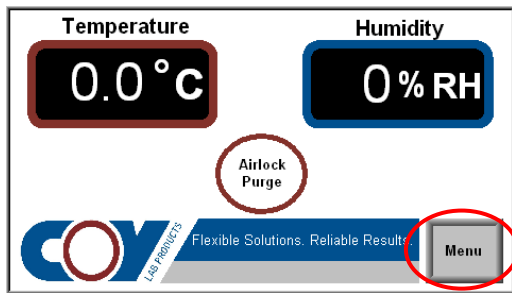

2. Press Airlock Timer button

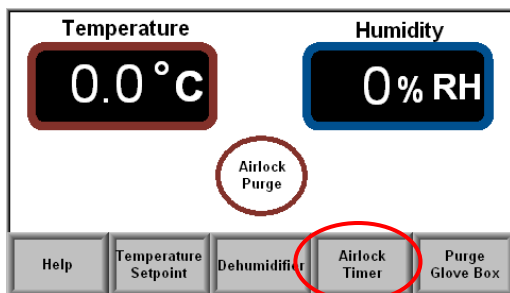

3a. Enter the desired time 1 of 3 ways. By clicking one of the 5 preset quick key times listed below the STOP button. *NOTE: The times are listed in seconds.* Once pressed the timer in the red block will change immediately. The purge can also be started or stoped from this screen.

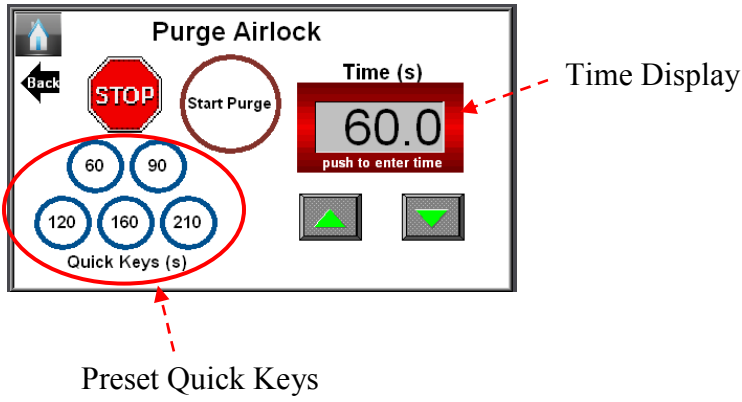

3b. The second option for adjusting time is to press the green arrows up or down. This method is typical used when slight adjustments are needed from an established time.

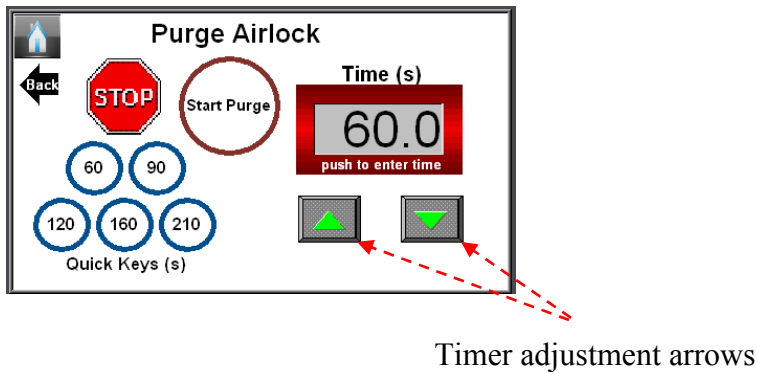

3c. The third option is to press the center of the timer display to bring up the timer number pad. Using the number pad you can enter the desired time (3 digit max) and press the enter button. Note the minus sign will allow you to enter a minus time but will not work. Esc button closes the number pad. Esc button closes the number pad.

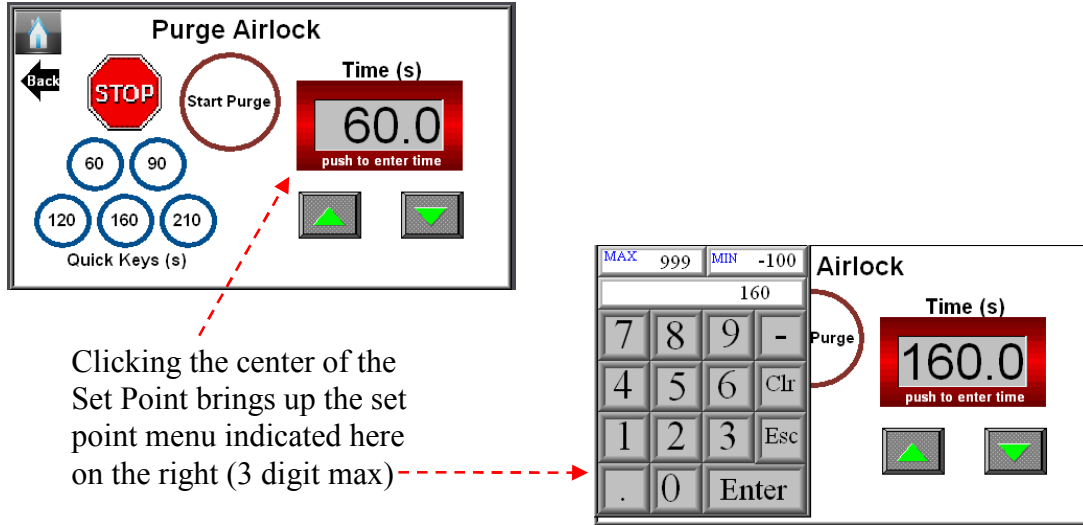

Clicking the center of the Set Point brings up the set point menu indicated here on the right (3 digit max)

Airlock operation both Manual and Automatic heated and unheated units.

1. Be sure both airlock doors are closed.

Automatic version only

2. Set the timer for the desired purge time in seconds. Below are the sample times suggested by COY Labs however it is important to note that these times were tested with empty airlocks and as close to atmospheric O2 as possible. Depending on your chambers recent activity these times may need to be adjusted to minimize gas consumption.

Automatic Purge Airlock Times

Gas = Nitrogen 95% Carbon Dioxide 5%

All measurements taken with a starting oxygen concentration of 20.9% (ambient)

Flow Rate (SCFH) <i>Standard Cubic Feet per Hour</i>	Time <i>(Seconds)</i>	Final O2 Concentration in the Airlock (%)
90	120	3.0
90	160	1.0
90	210	.05

Suggested purge times for given flow rates are given below. Experiment with your system to find the optimum setting for your application.

Above Ambient Airlock Purge Times
Gas = Oxygen 95% Carbon Dioxide 5%

Automatic Purge Airlock Times

Flow Rate (SCFH) <i>Standard Cubic Feet per Hour</i>	Time <i>(Seconds)</i>	Final O2 Concentration in the Airlock (%)
20	18	35
20	30	55

- Press the start button and be sure the gas flow rate is correct. Warning: you must check the flow rate as there is no warning light for lack of gas flow.

Manual Version Only

- Open the ball valve and purge glove box while manually timing the length of purge to match the desired O2 levels (see chart below). Ball valve is open when handle is parallel to the incoming gas line and closed when perpendicular.

Manual Airlock Purge Times

Flow Rate <i>PSI*</i>	Time <i>(Seconds)</i>	Final O2 Concentration in the Airlock (%)
15	25	10.0
15	40	5.0
15	60	2.0
15	100	0.0

**PSI is not a flow rate but for purposes of the manual airlock it can serve it's purpose with the COY supplied ¼" OD Flexible Tubing and Gas Regulator.*

Never Purge the airlock at a rate higher than 15 psi with ¼ OD Tubing.

3. Plug Strip

The six receptacle plug strip supplies proper voltage to the interior of the Glove Box. The outlets are used for continuously operating equipment, such as Fan Boxes, Incubator, and miscellaneous lab equipment you may wish to provide. The Plug Strip is sealed into the chamber through a feed through adapter with a rubber stopper. If the plug strip is adjusted for length, you may need to smear some fresh silicone around the outside portion of the feed through adapter to ensure the air tight seal.

4. Diaphragm Top

As the user enters the Glove Box through the Gloveless Sleeves, their hands are changing the volume inside the glove box. The Diaphragm Top expands and contracts with the changing volume, maintaining a comfortable and uniform internal pressure. The top of the Glove Box should be clear of all obstructions to allow the Diaphragm Top to fully expand (6-8"). If the Flexible vinyl material should be punctured, it is generally easy to fix with a piece of tape as a temporary fix. COY Labs does provide vinyl repair kits at no cost to repair small cuts in the vinyl.

5. Nitrogen (background) Gas Regulator

Gas Pressure Regulators decrease the pressure exiting from you gas supply (primary pressure) to a pressure suitable for the Airlock and Oxygen Controller (secondary pressure). The secondary pressure must **not exceed 10 psi** (4.2Kg/sq.cm), if the tanks are within approximately 10 feet (3 meter) of the airlock. If you extend the gas lines, you may need to set the regulators higher than 15 psi (1.4 Kg/sq. cm) to produce the same flow of gas. The Background Gas Regulator as supplied will fit a standard Nitrogen tank: however, if a CO₂/N₂ mix is used, then the supplied adapter will be needed.

Once the Gas Regulators are installed and all tubing is connected properly, slowly open the supply tanks. The primary pressure gauge will now display the amount of gas remaining in the tank. Turn the pressure gauge valve to regulate the gas flow to the airlock (secondary pressure gauge) to read 10 psi.

6. Heated Circulation Fan 2 Person Units Only

Use Figure #9 as a reference.

For temperature uniformity a second heated fan is added to the systems on the larger Two Person units. This fan has to be installed on the initial set-up as described on pages 13 and Figure #B. With the unit plugged into the COY supplied interior power supply the fan will begin to circulate by the temperature controls will need to be turned on and the set-point adjusted to the desired level.

The thermostat will control the temperature by turning the heat coils "on" and "off". When the coils are "on", a dot appears to the left of the temperature reading. The fan runs continuously while the power switch is "on" regardless of temperature setting. You may adjust the set point by simply pressing set point waiting for the display to change to SP and then adjusting the desired set point up or down. The "Entry" key must be pressed to accept the new set point.

Figure #9 Digital Controls for Heated Circulation Fan

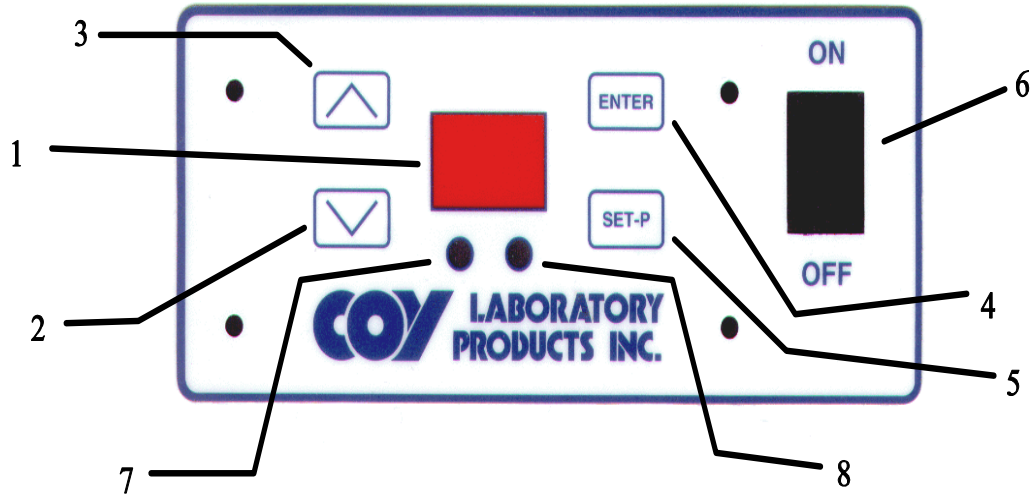

1. Display

Displays the temperature, set point or the tune values.

2. Down Arrow Key

Used to lower the set point or change the tune values.

3. Up Arrow Key

Used to increase the set point or change the tune values.

4. ENTER Key

Used to enter the value after it has been changed or to go to the next setting and also to enter the Hidden menu.

5. SET-P Key

Used to enter set point menu.

6. Main Power Switch

Used to turn power “on” and “off”.

7. Green Led

Used to indicate if the cooling output is “on” or “off”. (This can be disabled in the Hidden Menu)

8. RED Led

Used to indicate if the heaters are “on” or “off”.

PROGRAMING THE TEMPERATURE FOR SECONDARY HEATER

Use figure #9 as a reference

1. Press the SET-P Key(5) the Display(1) shows the letters “SP”, and then the Display will show the set point temperature.
2. Use the Up Arrow(3) or the Down Arrow(2) Key to change the temperature set point value.

(IMPORTANT: YOU MUST PRESS AND HOLD THE ARROW KEY WHEN CHANGING ANY VALUE. PRESSING AND RELEASING THE KEY WILL NOT CHANGE THE VALUE.)

3. After you reach the set point value desired press the ENTER KEY(4). Note: After the set point is reached there is a 20 second delay in the menu. If you have not pressed ENTER in that time frame the controller will exit this menu. The ENTER KEY(4) has to be pressed for the controller to accept the new set point value.

NOTE: When the heaters are on the Red LED (8) is turned on

8. Gloveless Sleeves & Arm Port Plugs

The Gloveless Sleeves and Arm Port Plugs are designed to allow barehanded access to the glove box while allowing a minimal amount of O₂ into the system. When used properly following the instructions below any O₂ allowed into the system is low enough to not even register on the O₂ Monitor and the little amount that is introduced is quickly purged out of the system.

1. Place your arms into the sleeves. Pull the latex cuff up onto your arms until there is a snug fit. Depending on the size of your arms, this may be the upper part of your lower arm, or the lower part of your upper arm.

A tighter, more secure fit is achieved when the cuff is in contact with the users bare skin. If placed over clothing it can result in a slow leak into the system resulting in higher gas consumption.

NOTE: Prior to entry into the glove box this does not have to be a perfect seal as you can make adjustments for comfort and seal more easily once you've entered the glove box interior and your off hand can be make the necessary adjustments.

2. Now grasp the Arm Port Plug handles and with a slight downward pressure tilt the Plugs into the glove box from the top down. Trying to push the entire Arm Port Plug into the glove box can be extremely difficult as you are pushing against the entire diameter of the Plugs seal.
3. When exiting the glove box reverse the procedure for the Arm Port Plugs, Seeding the bottom portion of the Plug into the Arm Port first and tilting the plug in from bottom to the top with a slight downward pressure.

NOTE: Different size cuffs are available from COY each unit is equipped with 6 pair of cuffs 2 pair of each available size. When reordering note the number marked on each cuff (#7, 8, 9) for proper sizing.

Warning: The Cuff material is a latex rubber for users with latex allergies take a glove of the appropriate material and cut off the glove portion just below the thumb and attach to the neoprene sleeve. See section 7.0 page 29 for details on cuff replacement procedures.

OXYGEN CONTROLLER OPERATION (refer to O₂ controller manual)

The sensor has an expected life of greater than 2 years. During that time, there may be a downward drift in the O₂ measurements. It is best to periodically (once a month) check the calibration. ***Refer to the O₂ controller manual and High accuracy calibration manuals for the procedure to calibrate the oxygen sensor.***

Contact Coy Laboratory Products, Inc. if the sensor requires frequent recalibration.

5.0 Establishing Initial Glove Box Atmosphere

Note: The Glove Box Purge will not operate if the airlock purge is purging..

- 1) Plug in and turn on the Oxygen Controller. At this point, it will be used only as a monitoring device so do not worry about choosing a set-point.
- 2) Turn on the gas supply attached to the Chamber. Adjust the regulator so as not to exceed 15 psi. Manual purge the chamber with the Ball Valve (unheated versions) located on the right hand side of the glove box or Purge Glove Box button on the Touch Screen Menu of the touch screen menu.

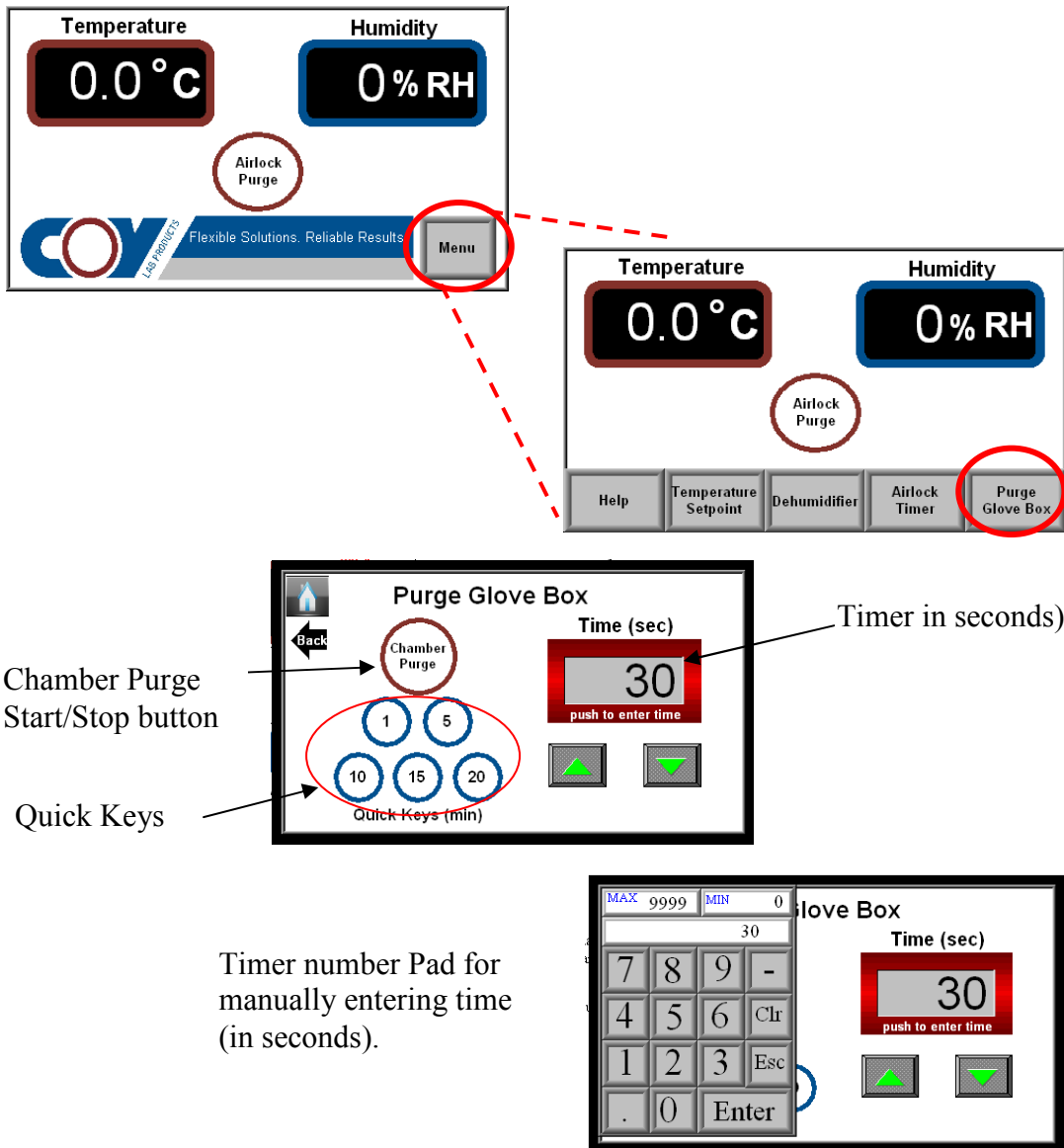

TIP: During Initial establishment or reestablishment of the desired O2 concentration it is not recommended to use a specific time but use the O2 Controller as a monitor. When you are within 1% of your desired set point turn the chamber purge switch off and allow the O2 Controller to complete the automatic purge to the desired set point.

Be sure to stay in attendance and monitor the filling operation. The relief valves are designed to handle 15 psi input in a working glove box. As you are filling the glove box, monitor the oxygen level. The red digits are the measured O2 reading inside the glove box, and the green digits indicate the set point. When you're within 1-2% of the desired O2 level close the ball valve or turn off chamber purge.

This process should take 5-15 minutes depending on the size of the glove box, flow rate, desired O2 level and additional content inside the glove box.

3) Now adjust the set point on the oxygen controller and flow rates (see O2 controller manual for details on set point adjustment) and allow the controller to adjust to your desired O2 levels. As the controller is purging in gas, you should adjust the flow rates on the flow meters on the front of the O2 controller. NOTE: Gas has to be flowing through the system to make the adjustments, 20 SCFH (Standard Cubic Feet per Hour) is recommended. However if using a tank of pure O2 and adjusting O2 levels up you will want to adjust the SP1 (Oxygen) flow to less than 2 SCFH to prevent overshoot and excess gas consumption. See the Tables in the O2 Controller Instruction Manual and in Section 4.0 O2 Controller overview for complete details on SP 1 (Oxygen) flow levels.

4) If using a Heated Unit turn "ON" the Temperature Controls and adjust the temperature to the desired set point. If the Automatic Dehumidifier option has been purchased you may turn the Humidity Controls "ON". *See section 4.0 for more information about humidity and temperature controls*

6.0 CARE OF POLYCARBONATE

- 6.1 There are several precautions you can take to prolong the life of your chamber. Precautions you should carefully follow are:
1. Do not use abrasive cleaners at any time.
 2. Do not use any solvent like liquids to clean the plastic. Isopropyl Alcohol is acceptable. **NOTE: If you have purchased the UV Light you can not use any cleaning material other than soapy water. Alcohol and Bleach solutions will degrade the plastic rapidly with the use of the powerful UV Light.**
 3. Keep Equipment and Shelving units within easy reach so you do not stretch the chamber sleeves.
 4. Rings and jewelry should be removed prior to using so as not to scratch the polycarbonate or tear the arms and gloves.
 5. Protect the chamber from organic solvent fumes and nearby painting and

plastering. If splashed wipe immediately while wet with a soft cloth.

6.2 CLEANING THE POLYCARBONATE

Dust and clean with a soft cloth or chamois having first sprayed on a plastic cleaner. (COY part no. 1600-480).

The use of a mild soap or detergent and plenty of water is good. Dry with a soft cloth or chamois.

Minor scratches can be removed by hand polishing. Polishes are best applied with a soft cloth dampened with water first. Several applications may be necessary, but most minor scratches can be reduced and the clarity improved in a short time.

6.3 Gloveless Sleeve & Cuff and Sleeve Length Glove Replacement procedure

If a hole is punctured in the glove, it must be replaced immediately or risk compromising the glove box atmosphere. Replacement Gloves, Gloveless Sleeves and Replacement Cuffs may be purchased from COY Laboratory Products. Page 7 is an illustration of how to install the replacement items.